



ARCHITECTURAL HARDWOOD DECKING, CLADDING & CEILING SYSTEMS

PROplank™

LINEAR TIMBER WALL
& CEILING LINING



1800 894 400
info@mortlock.com.au
www.mortlock.com.au







THE SYSTEM

Proplank™ is a click-together batten system designed for walls and ceilings. The Proplank mounting rail is mounted to a wall or ceiling (either suspended or directly to battens). Specially designed timber batten clips, holding the specified timber firmly in place and designed to hold black acoustic backing from behind, are clicked into the Proplank mounting rail and spaced apart with innovative nylon spacer clips. Proplank offers a range of batten shapes and sizes in various timber species which can be fixed together in your desired batten sequence and spacing between the battens.



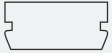
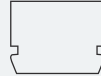

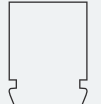
PROPLANK BATTEN SHAPES & SIZES

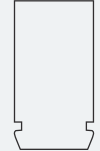
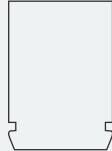

BLOCK PROFILE

 30mm x 20mm	 40mm x 20mm	 60mm x 20mm	 40mm x 30mm
 60mm x 30mm	 30mm x 30mm	 30mm x 40mm	 40mm x 40mm
 60mm x 40mm	 30mm x 60mm	 40mm x 60mm	

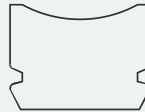
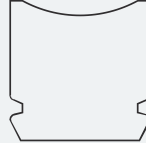

CONCAVE PROFILE

 60mm x 20mm	 40mm x 20mm	
 60mm x 30mm	 40mm x 30mm	 40mm x 40mm

DOMED PROFILE

 40mm x 40mm	 30mm x 30mm
--	--

PEAK PROFILE

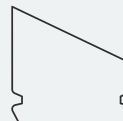
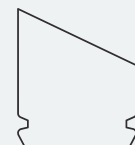
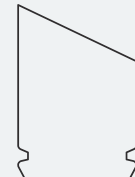
 30mm x 30mm	 30mm x 40mm	 30mm x 60mm
 40mm x 30mm	 40mm x 40mm	 40mm x 60mm

TIMBER BATTEN SPACING

The batten spacing is the measurement of the open space between each batten. Custom spacing is available the standard spacing starts at 10mm and increases in 5mm increments. 10, 15, 20 & 30mm spacing are the popular options.

Note: 60mm deep battens are not recommended for exterior use, please consult Mortlock Timber before specifying.



TIMBER SPECIES

The range of timber species have been specially selected for their aesthetics and suitability to the application. For special projects we have access to timber species outside of the list below from Australia, Asia, Europe and North America through our global supply contacts.



AMERICAN OAK	
Pricing	\$\$\$\$
Recommended Use	Interior



BLACKBUTT	
Pricing	\$\$
Recommended Use	Interior & Exterior



BURNT ASH	
Pricing	\$\$\$
Recommended Use	Interior & Exterior



VIC ASH	
Pricing	\$\$
Recommended Use	Interior



JARRAH	
Pricing	\$
Recommended Use	Interior & Exterior



PACIFIC TEAK	
Pricing	\$\$
Recommended Use	Interior & Exterior



SPOTTED GUM	
Pricing	\$\$
Recommended Use	Interior & Exterior

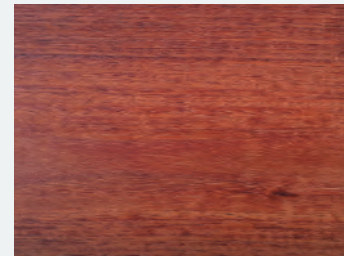

IRONBARK	
Pricing	\$\$
Recommended Use	Interior & Exterior



FINISHING

Timber can be supplied uncoated or fully pre-finished. The finishes below are factory applied prior to delivery to site.



NATURAL OIL

This is the standard coating supplied unless others are requested. Clear Cutek CD50 is a penetrating oil which is designed for external use and can also be used for internal applications. To maintain the natural timber colour an additional two coats are to be applied on site as per manufacturer's application and maintenance instructions.



FIRE SHIELD

TIMBERCLEAR 1FR clear timber intumescent coating is a factory applied coating that achieves a Group 1 and 2 fire rating to meet the requirements of the NCC with the Codemark Certificate of Conformity. TIMBERCLEAR 1FR can only be used on internal surfaces. Timber without TIMBERCLEAR 1FR coating will only meet Group 3 fire rating. All other components of the Proplank System will be supplied to meet Group 1 or 2 fire rating as required. TIMBERCLEAR 1FR is only available for projects 50m2 and above.

ENVIRO CLEAR

Enviro Clear is a water based LVOC product for interior use only. It is a film forming, non-yellowing coating which is easy to clean and requires minimal maintenance. Timber battens are sanded, and factory coated prior to delivery with Enviro Clear, providing a premium furniture grade finish for interiors. Minimum order quantity for 30m2 applies.



Note: Other timber finishes, including stains and poly-based products, are available for projects 100m2 and above, please contact us to discuss your requirements. Mortlock Timber provides warranties for the timber however cannot take responsibility for coating failure; this remains the responsibility of the timber coating manufacturer, consult Mortlock Timber before specifying.



FIRE COMPLIANCE

All natural Timber achieves a Group 3 rating according to AS 3837:1998. If Group 1 timber is required specify the Fire Shield TIMBERCLEAR 1FR coating (See page 5) If a BAL rated timber species, each timber offers different BAL ratings as per table below:

FIRE COMPLIANCE	
American Oak	Internal use only
Blackbutt	BAL 29
Burnt Ash	Not Compliant
Jarrah	BAL 19
Pacific Teak	BAL 19
Spotted Gum	BAL 29
Vic Ash	internal use only

If specific fire requirements and certification is required for your project, this must be requested and approved during the design phase to avoid delays during construction. If this is not requested prior ordering material, Mortlock Timber may not be able to provide the required certification.

ACOUSTIC PERFORMANCE

All natural Timber achieves a Group 3 rating according to AS 3837:1998. If Group 1 timber is required specify the Fire Shield TIMBERCLEAR 1FR coating (See page 5) If a BAL rated timber species, each timber offers different BAL ratings as per table below:





PRICING & TENDER SUBMISSION

For budget m2 pricing it is helpful to have the information in the list below:

WHAT YOU NEED TO KNOW	Approximate M2 required.
	Batten Size (Page 3)
	Batten Shape (Page 3)
	Spacing between battens (Page 3)
	Timber Species (Page 5)
	Finish (Page 7)
	Acoustic Backing Required
	Interior or Exterior Application?
	Information on any certification required I.e. Fire and Acoustic requirements if available.

For tender and project pricing our consultants are able to assist with budgeting and quotations for projects large or small. To make large scale projects and tenders easier we are able measure from PDF drawings which are returned with a detailed BOQ and quotation for cross referencing. We also offer face to face proposal presentation where required.

Note: Generally, the Proplank system is suited to projects 50m2 and above. Orders under 50m2 will include a small production run fee.

EXAMPLE SPECIFICATION	
Product Name	Proplank Timber Batten Lining System
Timber Species	Timber Species
Finish	Cutek CD50 Clear Oil
Batten Size & Shape	30x30 Square
Spacing between battens	15mm
Acoustic Backing	9mm Proplank Acoustic Board, Black (comes standard)
Acoustic Requirements	N/A
Fire Requirements	Group 3
Contact	Mortlock Timber Group 1800 894 400 info@mortlock.com.au www.mortlock.com.au



CEILING INSTALLATION PROCEDURE

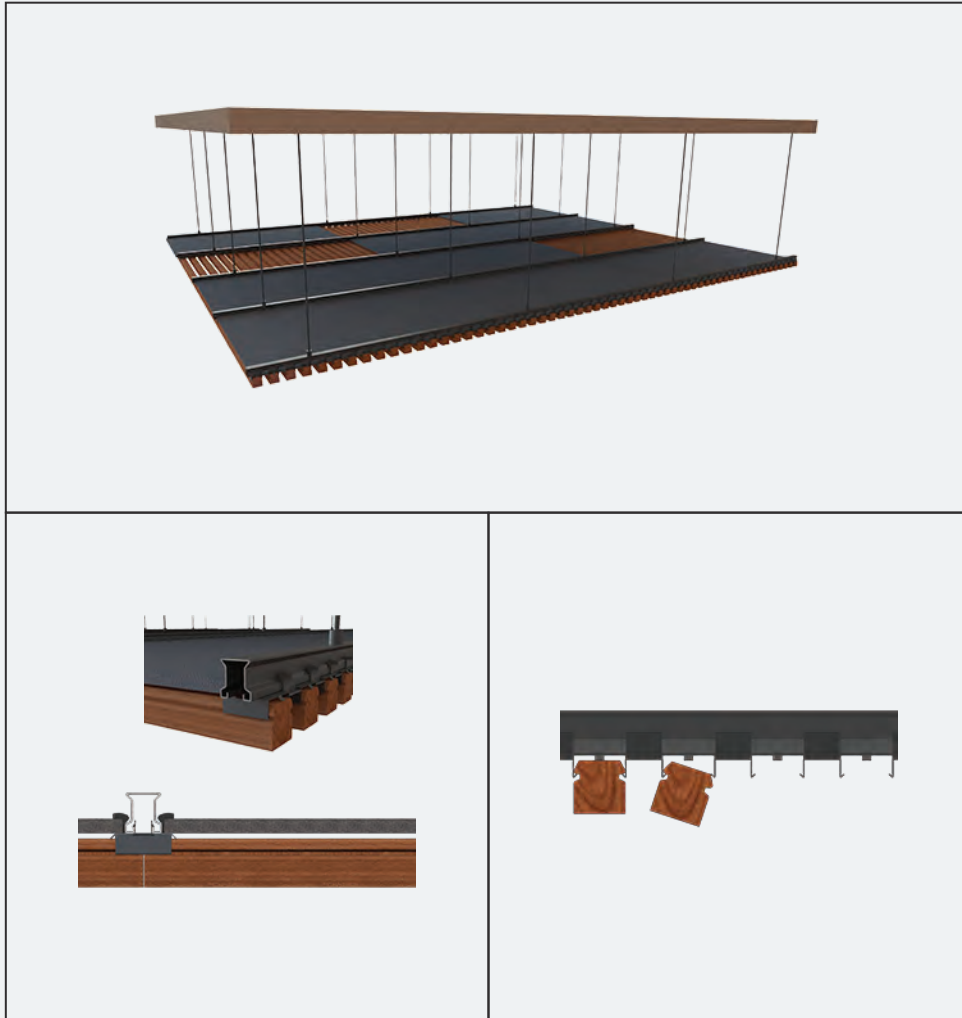

STEP 1

SUSPENDED CEILING

Suspend Proplank Mounting Rail (TCR) at the required spacing depending on the weight of the selected timber batten sequence.

Note: Mortlock Timber only supplies the components from the Top Cross Rail Down, hangers and suspension clips etc. is supplied by the installer or builder.

DIRECT FIX CEILING

Screw fix the Proplank Mounting Rail directly to ceiling substrate

STEP 2

Start clicking the batten clips and spacer clips into the Proplank Mounting Rail lining up the clips on each rail as you go. Keep in mind that battens may need to creep slightly so a full batten finishes at the end. On suspended ceilings, a batten can be clicked into the clips to hold an even spacing between the mounting rails.

STEP 3

If acoustic backing is required, fit these into the grooves of the spacer clips which hold the backing in place. Standard Proplank acoustic backing sheets are supplied cut to fit mounting rails fixed at 600mm centres. Other sizes are available on request. Acoustic backing can be cut with a trimming knife or a panel saw where required.

STEP 4

Click the battens onto the clips, working from one side to the other, and leaving gaps around penetrations. All battens must be joined on a clip.



WALLS INSTALLATION PROCEDURE

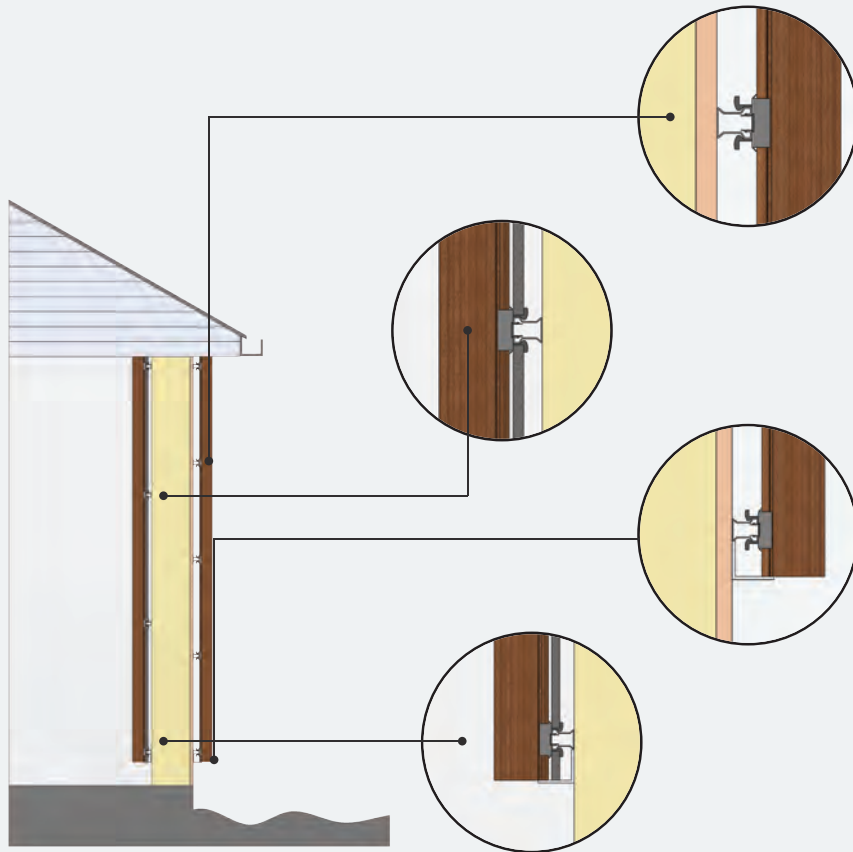

STEP 1

Ensure all skirting, end stops and substrate is installed where required. Screw fix the Proplank Mounting Rail to the substrate, whilst framing out around penetrations.

STEP 2

Start clicking the batten clips and spacer clips into the Proplank Mounting Rail lining up the clips on each rail as you go. Keep in mind that battens may need to creep slightly so a full batten finishes at the end.

STEP 3

If acoustic backing is required, fit these into the grooves of the spacer clips which hold the backing in place. Standard Proplank acoustic backing sheets are supplied cut to fit mounting rails fixed at 600mm centres. Other sizes are available on request.

STEP 4

Click the battens onto the clips, working from one side to the other, and leaving gaps around penetrations. All battens must be joined on a clip.



DIRECT FIX INSTALLATION PROCEDURE

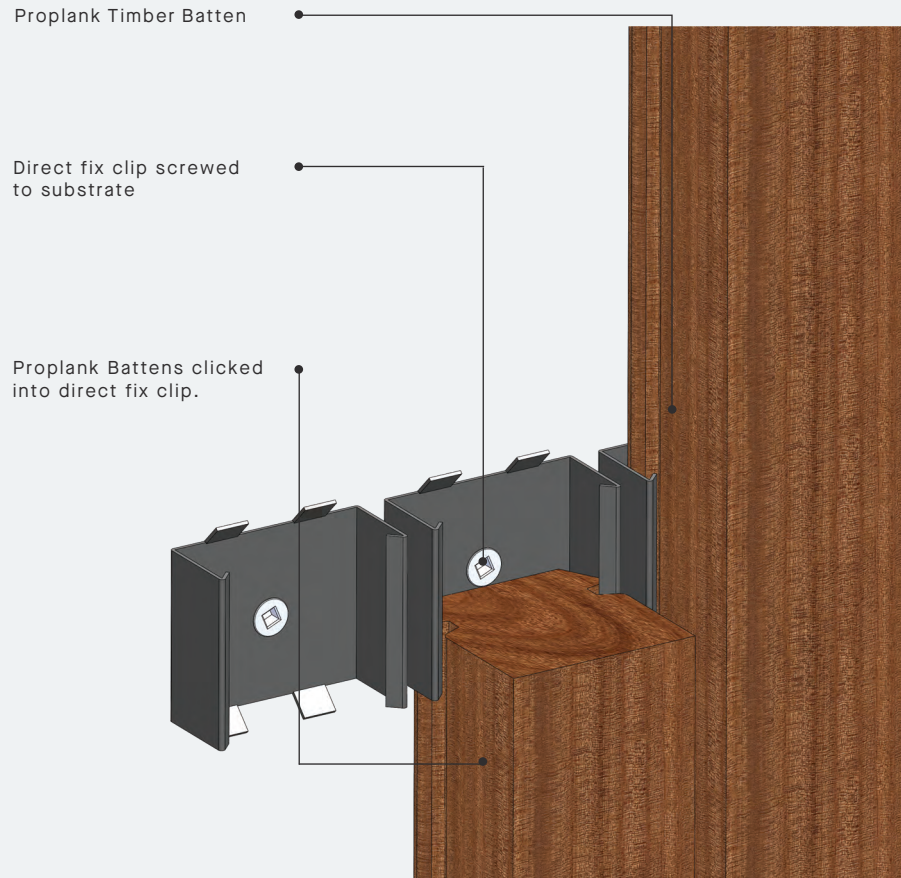

Direct fix clips are used where the Proplank mounting rail is not required. The clip allows battens to be fixed directly to the substrate

STEP 1 Screw fix direct fix clips to the substrate in the desired sequence and spacing

STEP 2 Trim battens to length and click into clips.

Note: The direct fix clips are commonly used in the following applications:

- Battens are to be spaced at 100mm or above.
- Battens are to be fixed direct to the substrate with no mounting rail.
- Exterior screening and façade applications



ACCESS PANELS

This hatch detail is completely fabricated onsite using standard components.

STEP 1 Mark out the access hatch outline on the underside of the ceiling

STEP 2 Cut out with a jigsaw and save the pieces.

STEP 3 Cut two lengths of Proplank Mounting Rail one clip larger than the opening.

STEP 4 Adapt the end clips as shown in drawing.

STEP 5 Click the battens into place on the Proplank Mounting Rail making sure that the grain match with those alongside.

STEP 6 Drop the panel into place.

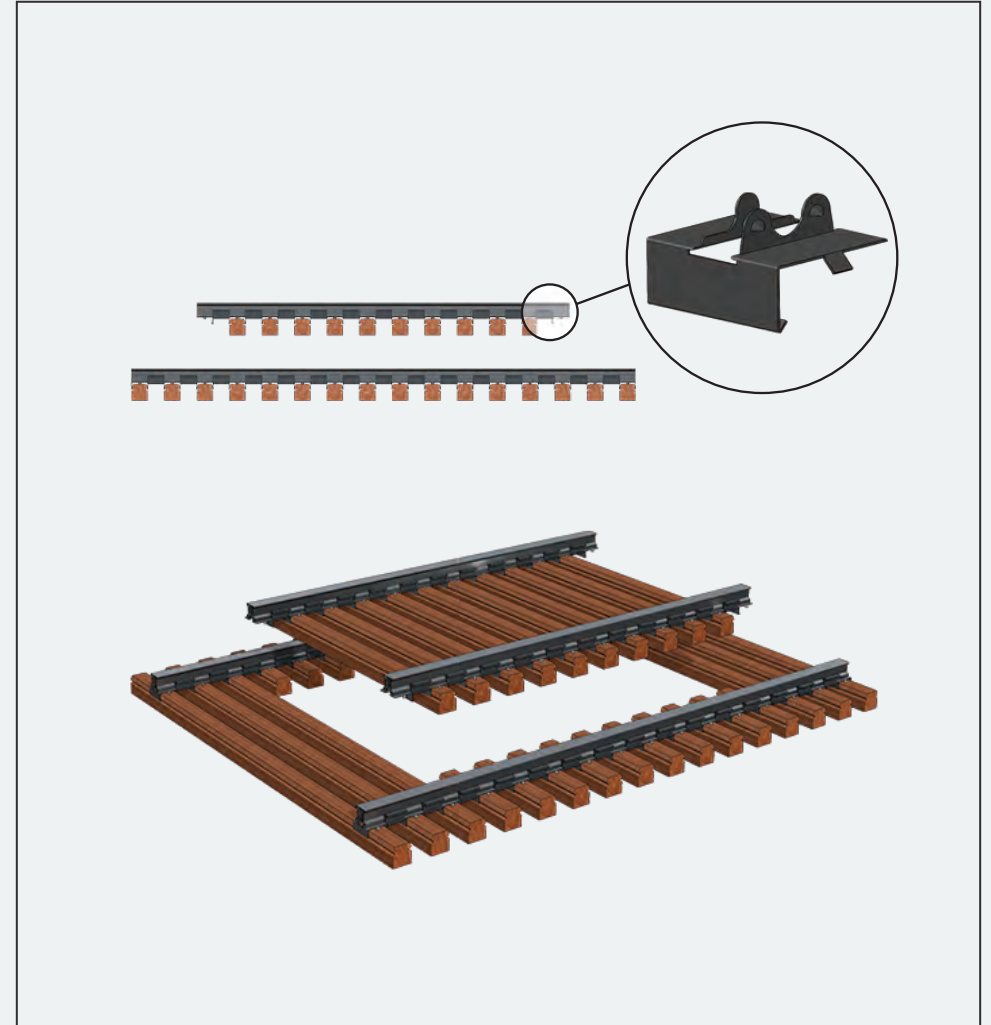



END STOPS

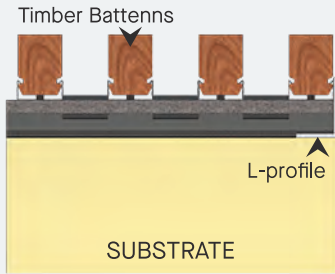

ALUMINIUM L PROFILE

1. Screw L-profile to substrate, flush with the adjoining surface.
2. Notch out bottom of the mounting rail and fix over one side of the aluminium angle.

Note: Aluminium can be powder coated to meet requirements.

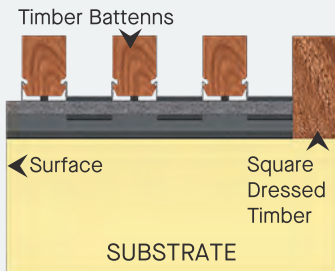

SQUARE DRESSED TIMBER

1. Fix the square-dressed timber to the substrate, flush with the adjoining surface.
2. Work away from the junction, ensuring the battens maintain sequence.

Note: Mortlock Timber can profile timber the right size to suit batten selection.

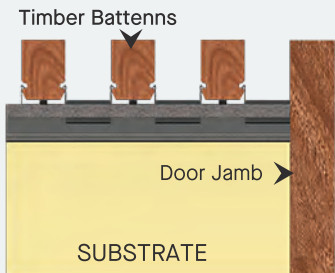

SQUARE DRESSED TIMBER

1. Fix the door jamb to the substrate.
2. Work away from the door jamb, ensuring the battens maintain sequence.

Note: Mortlock Timber can profile timber the right size to suit batten selection.





CORNER JUNCTIONS

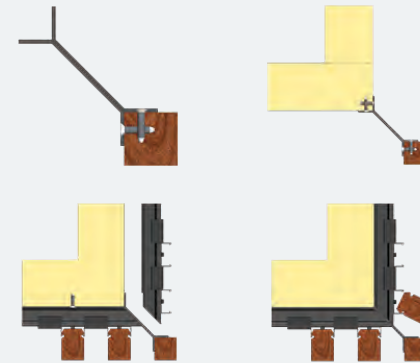

VERTICAL CORNERS

Proplank offers a standard corner bracket with timber which is suitable for most projects however they may not be the solution for every project. If the suggestions below are not suitable contact our team to discuss the options.

1. Screw Proplank Corner Bracket to Wall.
2. Screw timber to Proplank Corner Bracket.
3. Mitre the end and notch out the back of the Mounting Rail then fix to wall.
4. Mount clips on to rail at the correct spacing from the corner batten.
5. Clip in Wall Battens.

HORIZONTAL CORNERS

When installing horizontal Proplank, corners are normally mitred and pinned together to maintain alignment (as shown).

Its recommended you cut and install the mitred battens first to ensure alignment, then proceed with installing the rest of the wall.

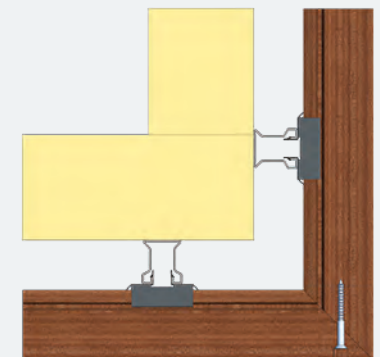



MOUNTING RAILS CENTERS

Interior Applications	600mm
Exterior Applications	450mm

Acoustic Backing Sheets are pre-cut to suit 600mm rail centers, we recommend checking the spacing between the mounting rail using a sheet of acoustic backing to ensure correct width.

PROPLANK DEPTH

The depth of the Proplank system is 27mm + Timber Batten Depth as per diagram below. For example: 30x30mm batten will be a total depth of 57mm.



BATTEN CANTILEVER DISTANCE

Timber Batten End should be no more than 100mm from the last fixing clip





BATTEN JOINT OPTIONS

Note: Before specifying the end joints, ask Mortlock Timber which one is the suitable option for your project.

END MATCHING

End matching is a small tongue and groove profile on the ends of the battens. When engaged, these profiles help to maintain batten alignment at the butt joints. This allows battens to be joined off the mounting rail to reduce waste. They still require a clip fitted over the join as per steps below. End matching must be specified if required.

1. Push the tongue and groove together.
2. Click batten into clips fastened to the mounting rail.
3. Click a loose clip over end matched join ensuring the clip is evenly positioned over each batten.

FLAT END JOINING BATTENS

All battens must be joined over a clip as per steps below

1. Cut battens so the end finishes half way through the clip
2. Click the first batten into place.
3. Click next batten into place and tap opposite end with rubber mallet to close the gap between the battens.

FESTOOL DOMINO JOINT

Domino Jointing is the recommended joint for the Proplank Batten System. Although it takes slightly more time than other joints, it is the most successful way to maintain batten alignment. All battens must be joined over a clip.

1. Cut battens so the end finishes half way through the clip.
2. Using the Festool Domino System, drill the batten ends with the Festool Jig, further information can be found at www.festool.com.au/festool-systems/domino-500-system.
3. Apply a small amount of glue (so it doesn't squeeze out the end) in each hole & insert domino.
4. Join battens, ensure correct end alignment.
5. Click battens into clip or apply loose clip over join if joining off mounting rail.

Note: Mortlock Timber does not supply the tools to create the Festool Domino Joint.



CURVED WALLS & CEILINGS

The curved ceiling or wall substrate is produced by others. This is a pre-cut substrate that is normally made of MDF Board or sometimes can be suspended. Mortlock Timber supplies the Mounting Rail pre-curved to the required radius, this allows for a perfect curve as all rails will line up perfectly. For Mortlock to provide the rails with a correct curve, a drawing or template with the radius is required from the contractor.

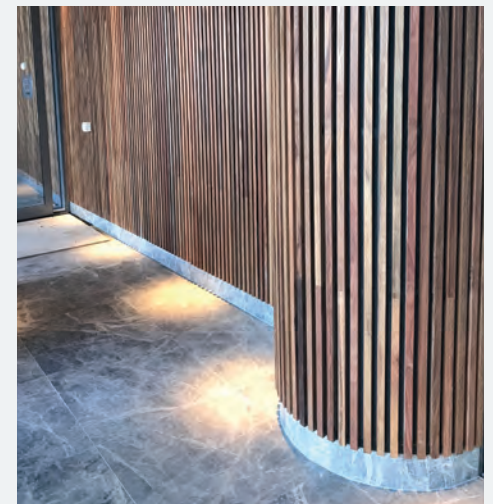
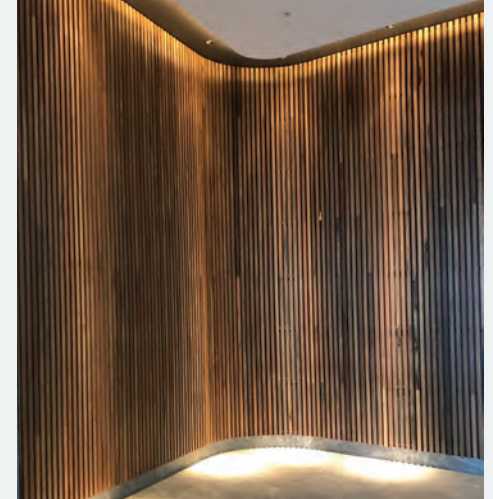



FURTHER INFORMATION

ONSITE STORAGE

Mortlock Timber kiln dry the timber to Australian Standards. It is recommended to install the timber as soon as possible after delivery so that it maintains its accuracy and straightness. If possible, the timber should be kept in its original pack until installation. If it is repacked, it should be done the same as the original pack to maintain straightness and quality. Ensure that it is at least 50mm above ground and stored on a flat surface to prevent bowing. It should be stored in a cool dry place out of the weather until ready to install.

WARRANTY

Mortlock Timber provides project specific warranties.

MAINTENANCE

Poly and Fire Shield Coating Interior timber does not normally need maintenance. It is important to regularly check timber which is exposed to UV light through windows etc. as sometimes this can lead to yellowing of the coating. Re-coating and/ or regular cleaning may be required.

Cutek CD50 Clear Oil. When timber is not exposed to direct sunlight (for example interior use or exterior soffits), Clear oil maintains the timbers natural colour. When timber is exposed to sunlight, using Clear Oil will allow the timber to silver unless an additional pigment is used to tint the clear oil. Mortlock Timber recommends recoating these applications every 12-18 months. Further maintenance information on Cutek Oil can be found at www.cutek.com.au

CLEANING

If cleaning is required this can be done with a soft bristled broom running in the direction of the timber. Any stains can be treated with warm soapy water or timber cleaners compatible with the coating.





PROJECT DETAILS	
Project	Botanical Apartments
Location	Subiaco, WA
Batten Size	40×40
Timber Species	Blackbutt
Batten Spacing	10mm
Finish	Natural Oil

PROJECT DETAILS	
Project	Private Residence
Location	Swan Valley, WA
Batten Size	60×20
Timber Species	Pacific Teak
Batten Spacing	15mm
Finish	Natural Oil





PROJECT DETAILS	
Project	Corpus Christie Theatre
Location	Manning, WA
Batten Size	40x30
Timber Species	Vic Ash
Batten Spacing	15mm
Finish	Enviro Clear



PROJECT DETAILS

Project	His Majesty's Theatre
Location	Perth, WA
Batten Size	40×20
Timber Species	Ironbark
Batten Spacing	20mm
Finish	Fireshield



PROJECT DETAILS	
Project	Iglu
Location	South Melbourne
Batten Size	60x20
Timber Species	Blackbutt
Batten Spacing	20mm
Finish	Natural Oil





PROJECT DETAILS	
Project	Office Fitout
Location	Wagga Wagga, NSW
Batten Size	30x20
Timber Species	Vic Ash
Batten Spacing	10mm
Finish	Natural Oil

PROJECT DETAILS	
Project	Toyota Headquarters
Location	Kewdale WA
Batten Size	60x40
Timber Species	Vic Ash
Batten Spacing	30mm
Finish	Natural Oil



PROJECT DETAILS

Project	Ruskin
Location	Elwood, VIC
Batten Size	40×20
Timber Species	Spotted Gum
Batten Spacing	15mm
Finish	Natural Oil



PROJECT DETAILS	
Project	Comets Soccer Club
Location	Adelaide, SA
Batten Size	30x20
Timber Species	Vic Ash
Batten Spacing	20mm
Finish	Natural Oil





PROJECT DETAILS	
Project	Private Residence
Location	Adelaide, SA
Batten Size	40x20
Timber Species	Blackbutt
Batten Spacing	15mm
Finish	Natural Oil



PROJECT DETAILS	
Project	Cirque Apartments
Location	Applecross WA
Batten Size	40x30
Timber Species	Pacific Teak
Batten Spacing	15mm
Finish	Natural Oil



DESIGN & INSTALLATION CONSULTING

Our team can work through detailing and specification requirements to meet specific project requirements. We can assist with budget management without compromising aesthetics and ensure our products perform with an extended life cycle.

SAMPLES

Mortlock Timber Group samples department is stocked with our full range. We use express delivery service and generally deliver samples to your door within 2-3 days. Custom samples and sample boards can take 3-6 weeks depending on requirements.



W: www.mortlock.com.au

T: 1800 894 400

E: info@mortlock.com.au

Distribution: WA | SA | VIC | NSW | QLD | TAS